

| | | | |
|---|---|--|--|
| TAVOLA 05/a | | COMUNE DI CENTO - PROVINCIA DI FERRARA PIANO PARTICOLAREGGIATO DI INIZIATIVA PRIVATA | |
| OGGETTO | ANFFAS ONLUS CENTO (FE) | VIA DEI TIGLI N° 2/B C.F. e P.I. 90007460380 | |
| DESCRIZIONE | VARIANTE AL PIANO PARTICOLAREGGIATO DI INIZIATIVA PRIVATA COMPARTO C13 | PROGETTO E DIREZIONE LAVORI | |
| PROGETTO | PLANIMETRIE, PROFILI LONGITUDINALI | COMMITTENTE | |
| RETE GAS | | ANFFAS ONLUS CENTO Via Dei Tigli n. 2/b - 44042 Cento (FE) | |
| Dott. Ing. Cristiana Pareschi via XII Morelli, 40 - 44045 XII Morelli (FE) | | IL PRESIDENTE Giordana Govoni | |

STUDIO TECNICO Geometra FAUSTO PARESCHI
 WWW.STUDIOPARESCHI.IT - VIA PROVENZALI, 12 INT. 12 - 44042 CENTO (FE) - TEL./FAX 051 9014533 - CELL. 346 872032 - E.MAIL studiopareschi@studiopareschi.it
 © A. TERMINI DI LEGGE LA PROPRIETA' DI QUESTO ELABORATO GRAFICO E' RISERVATA. RIPRODUZIONE ED UTILIZZO ANCHE PARZIALE METRO SENZA AUTORIZZAZIONE.

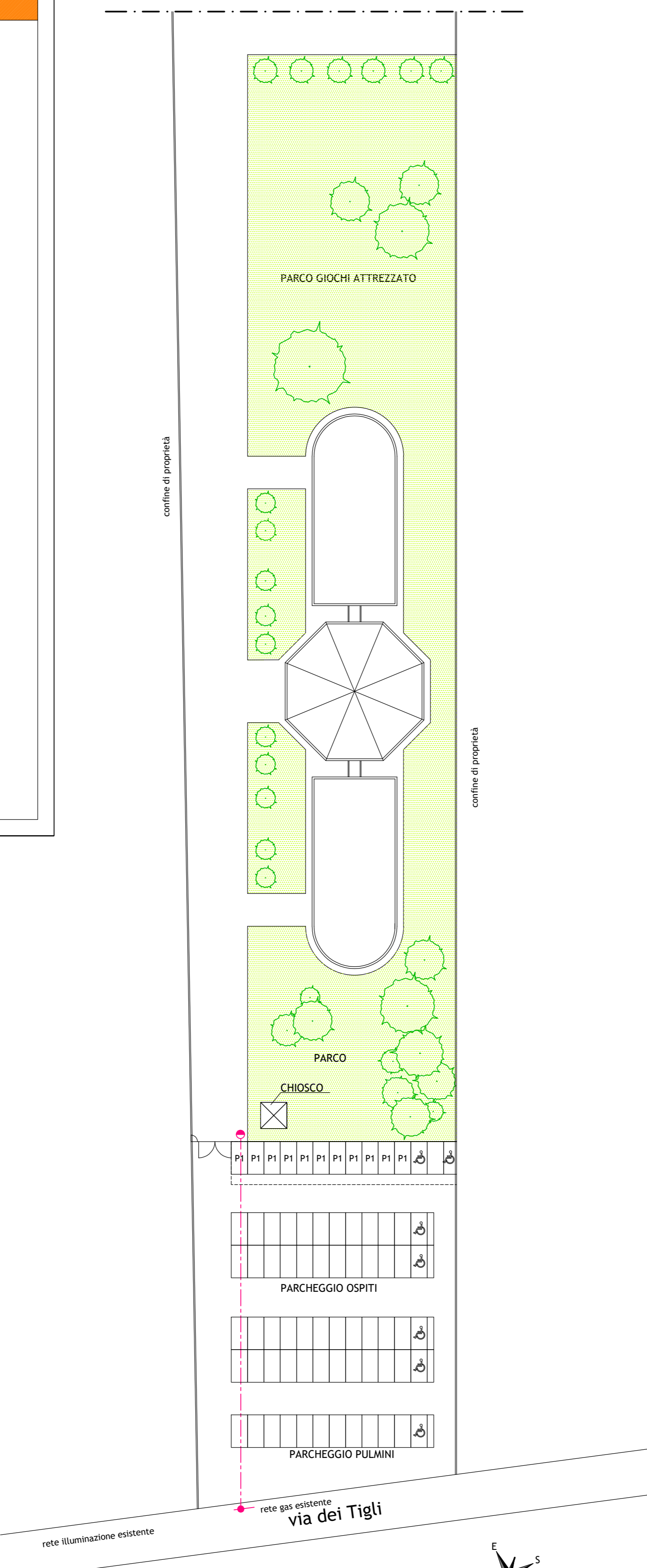

LEGENDA RETE GAS METANO

| | |
|--|---|
| | RETE IDRICA DN 100 IN ACCIAIO |
| | FLANGIA CIECATA |
| | ALLACCIO UTENZA CON INTERCETTAZIONE E CONTATORE |
| | ALLACCIO ALLA RETE DEL GAS ESISTENTE |

STATO APPROVATO
 PLANIMETRIA GENERALE
 SCALA 1:500

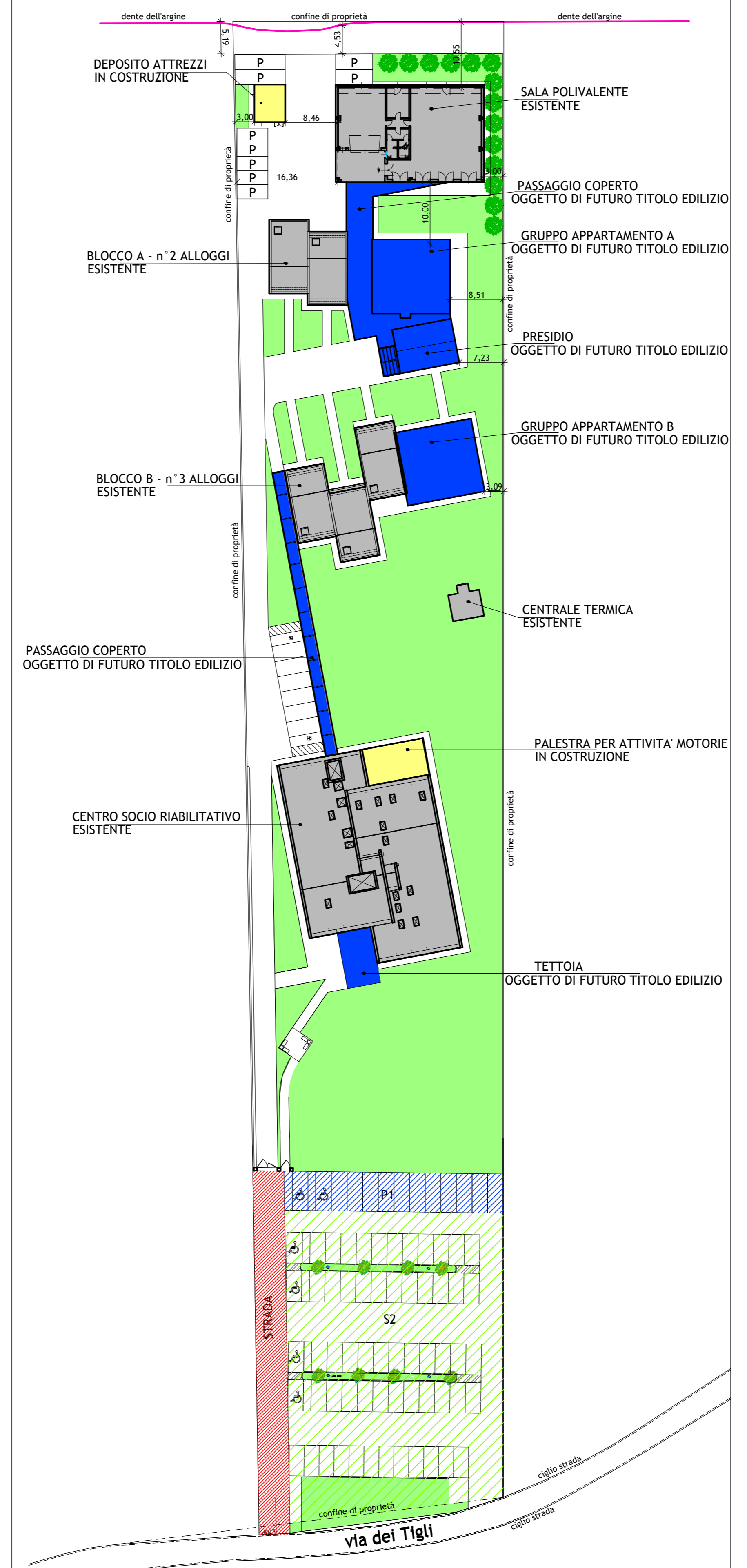

STATO DI PROGETTO
 PLANIMETRIA GENERALE
 SCALA 1:500

LEGENDA

| | |
|--|--------------------------------------|
| | ESISTENTE |
| | IN COSTRUZIONE |
| | OGGETTO DI FUTURO TITOLO ABILITATIVO |

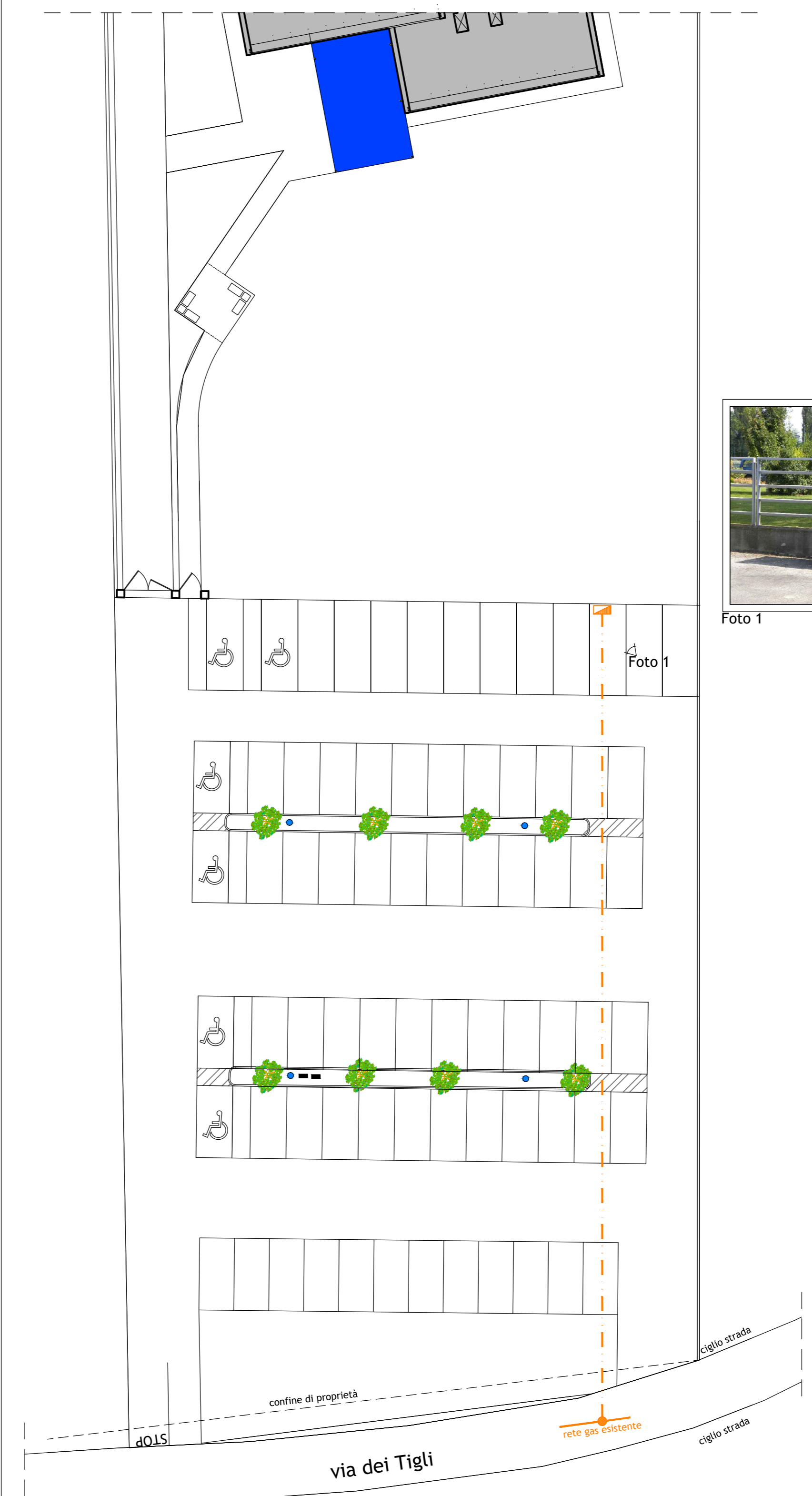

SCHEMA RETE GAS METANO
 SCALA 1:250

LEGENDA RETE GAS METANO

| | |
|--|---|
| | ALLACCIO UTENZA CON INTERCETTAZIONE E CONTATORE |
| | FLANGIA CIECATA |
| | ALLACCIO ALLA RETE DEL GAS ESISTENTE |

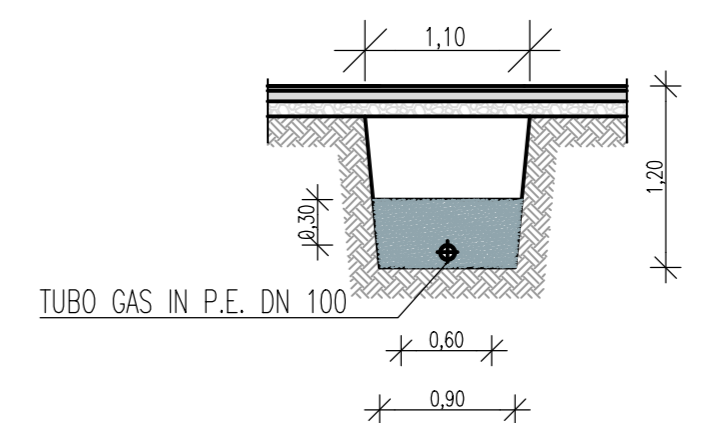
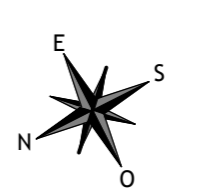

SEZIONE SCAVO
 SCALA 1:50



Foto 1



Foto 1



Foto 1



Foto 1



Foto 1

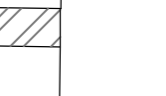

Foto 1



Foto 1

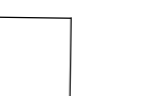

Foto 1



Foto 1



Foto 1



Foto 1



Foto 1



Foto 1



Foto 1



Foto 1



Foto 1